

GENERALAGENT
EPOX
SOLLENTUNA www.epox.se 08-754 71 60



VON ARX DUST EXTRACTORS

T7 / T8



EN

**von
arx**®
TRUE QUALITY SINCE 1941

TABLE OF CONTENTS

Notes for the user	5
Before using.....	5
Reading this Operating Manual	5
Copyright ©	5
Trade marks ®.....	5
Patents.....	5
Illustrations and technical modifications	5
Translations	5
Safekeeping	5
Further information.....	5
Product specifications	6
Intentional use	6
Safety instructions and marked parts	6
Product responsibility	6
Definitions of safety measures	6
Safety instructions.....	6
Product overview.....	8
Setting up	8
Operation.....	8
Connecting the product.....	8
Operating the machine.....	9
Pre-filter cleaning	10
Filter change	11
New Longopac dust bag assembly	12
Caring and Maintenance	13
Troubleshooting	13
Technical specifications	14
Spare parts and accesoires	15
Warranty.....	16
EC Declaration of Conformity	17

NOTES FOR THE USER

Before using

It is extremely important that you:

- Make sure that the package is complete and that you check for any possible damage caused during transit/transport.
- Observe the safety instructions.
- Read the Operating Manual

Reading this Operating Manual

If there are any questions on your part after reading this Operating Manual please get in touch with the manufacturer or the nearest service center. The manufacturer is not responsible for any damage or breakdown resulting from non-observance of the Operating Manual.

Copyright ©

The text and illustrations may not be copied or reproduced without the express permission of Von Arx EOOD.

Trade marks ®

The words "Von Arx" and the "Von Arx" logo are registered and internationally protected trade marks. Their use by third parties is prohibited!

Patents

Various components and processes listed and illustrated in this Operating Manual are patent pending or national and international patents have already been granted.

Illustrations and technical modifications

Illustrations may differ from the real machine and appear without any obligations on our part. In order to meet the rapidly changing customer demands, we reserve the right to make technical modifications without prior notice.

Translations

Solely the English version of this Operating Manual is legally binding. The English version of this manual is considered as the "Original instructions".

Safekeeping

Please keep this Operating Manual in a safe place and available for the user.

Further information

Manufacturer:

Von Arx EOOD,

4000 Plovdiv

Telefon: +359 32 94 05 53

Country of origin: Bulgaria

PRODUCT SPECIFICATIONS

A dust extractor is a machine which extracts, separates and collects dust. The extraction, separation and collection process is performed by a vacuum pumps via 3-way filtering system into a collection bag.

Intentional use

The dust extractor T7/T8 are intended for commercial use.

The machine is designed for collecting and extracting dry, non-combustible dust with an explosion limit value of $>0.1\text{mg}/\text{m}^3$.

SAFETY INSTRUCTIONS AND MARKED PARTS

Product responsibility

According to the product liability laws, we are not responsible for damages caused by our product if:

- The product has been improperly repaired.
- The product is repaired with non-manufacturer or non-manufacturer-approved replacement parts.
- The product is equipped with a non-manufacturer or non-manufacturer-approved accessory.
- The product is not repaired at a certified service facility or by a certified authority

Definitions of safety measures

Warnings, cautions, and remarks are included to call attention to sections of the manual that are especially important.



Failing to observe an instruction marked with this sign may lead to serious injury or death.



Failing to observe an instruction marked with this sign may damage the machine or cause damage to property.



Marks any explanatory information or special instructions.

Safety instructions



Always exercise caution and common sense. This section describes the product's fundamental safety instructions for use. This information can never replace professional abilities and experience. Stop and contact a certified technician if you find yourself in a situation where you feel unsafe. Do not undertake tasks in which you lack confidence!



Before using the dust extractor, please read the safety regulations and the entire operator's manual attentively. This manual applies exclusively to the dust extractor T7/T8.















- Verify that you have read and comprehended the product's instructions to ensure that you know what personal protective equipment to wear, what safety equipment to employ, and how to operate the product safely



The dust extractor may only be used with dried, non-explosive substances.



Never allow minors or other untrained individuals to use or service the product. Never allow anyone else to use the product before verifying that they have read and comprehended the operator's manual.

-  Ensure the assembly area is stable to prevent the product from toppling over. Possibility of physical and injury.
-  Do not move the product by tugging on the hose.
-  The toggle fastener poses a risk of pinching.
-  Original replacement parts must be used for the dust extractor T7/T8.
-  Before performing maintenance on the dust extractor, all connected products must be turned off and disconnected.
-  Dust that can be hazardous to one's health and may be dispersed when cleaning the product. Use protective eyewear, gloves, and a respiration mask class FFP3.
-  Do not puncture the Longopac bag. Potential for dust dispersal.
-  Damaged power cables can be dangerous and should be replaced immediately.
-  Improper connection of the grounding conductor and any modification of the provided power plug can result in a risk of electrical shock. Advise and carry out installation by a qualified electrician.
-  Before using the dust extractor, make sure that the power & voltage corresponds with the machine's rating plate.
-  Do not use outdoors or on wet surface, this machine is for indoor and dry use only.
-  Do not put any object into or block the air inlet (besides during filter cleaning procedure).
-  Keep hair, loose clothing, fingers and all body parts away from the suction inlet.
-  Do not use without a collection bag and filters in place. Replace if damaged or clogged.

Safety stickers on the machine



Use protective equipment!

Damaged or lost safety stickers must be replaced immediately. These stickers are obtainable from your Customer Service Center.

PRODUCT OVERVIEW

1. Input from the machine (scarifier, shaver e.t.c)
2. Longopac dust bag
3. Longopac holder
4. Toggle fastner to pre-filters
5. Toggle fastner to HEPA filter
6. Rubber wheels
7. Rubber wheels with brakes
8. Air flow regulator valve
9. Toggle fastener to air flow regulator
10. Polyester pre-filter cleaning lever
11. Electric cabinet
12. Filter clog manometer
13. Three-phase power input
14. Three-phase power outlet (T7 US version, T8)
15. Inlet closing mechanism

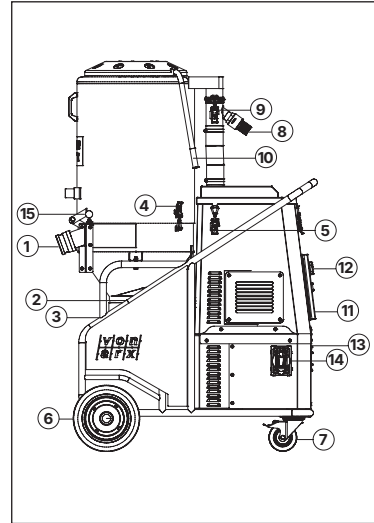

SETTING UP

When unpacking the product, verify that it is undamaged and that the included accessories are present:

- 2 types of hoses with adapters - 7,5 m x 50 mm & 10 m x 76 mm
- 3 pieces 2" wand
- Floor tool with rubber blades
- Longopac collection system

If any of the accessories are missing, please contact your local distributor or a sales representative.

OPERATION

Connecting the product

Direct connection

You can connect the dust extractor with machine via attached hose - 10 m x 76 mm with camlocks (A) 3", or with flooring tool via 7,5 m x 50 mm hose (B).

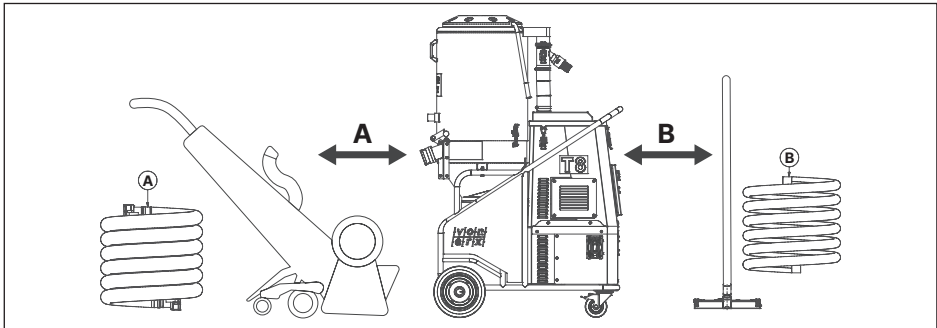

Connection with pre-separator

The usage of a pre-separator upgrades the overall filter cleaning system of the dust extractor to a full 4-stages process. Follow the picture to connect the pre-separator to the dust extractor. The front inlet of the pre-separator should be hooked up to the machine (A), and the rear outlet of the pre-separator should be hooked up to the dust extractor inlet (B).



Use only Von Arx recommended pre-separators.

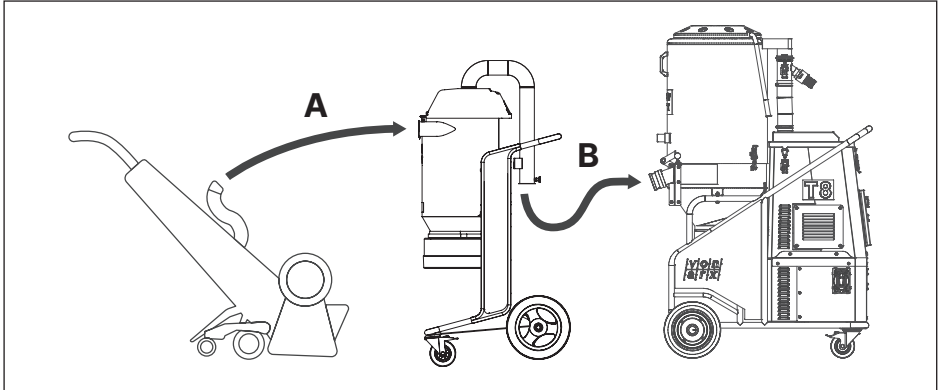

Operating the machine

The dust extractor is started by the green button on the electrical cabinet. If the red lamp between the red and green buttons light up, there is a phase reversed and two of the phases must be switched. This protection measure ensures that the pump doesn't start to blow air instead.

Once the dust extractor is started the dusty air is sucked through the inlet and the suction hose at high speed. Large dust particles are separated into the cyclone while the air is slowing down. The air containing the fine dust particles continues through the double filter system where separation is made. The accumulated dust into the cyclone is released through the bottom flap into the plastic bag once the dust extractor is switched off by pressing the red button that is located directly below the start button on the electrical cabinet.



The machine is designed for reverse air pulse filter cleaning. The filter cleaning process is completed once the dust from the tank falls into the collection bag.

In some cases the dust can be stuck on the inner side of the tank or the collecting bag. To release it one must hit the dust through the bag or tap the tank using a rubber hammer.

The dust extractor is equipped with a safety thermal motor protection to prevent overheating. If the thermal protection is activated the motors will switch off. Turn off machine, unplug it and check for full dust bag, hose clog or filter blockage. It may take up to an hour for the thermal protection to reset.



Make sure the intake valve is in the lower position before you start the machine.



Before use, the operator must be trained in the handling of the dust extractor and the hazardous dust.



The pre-filter and the Hepa filter need to be changed if the pressure stays low.

Pre-filter cleaning

Sometimes you have to clean the filter. This needs to be done before the bag collection system is changed, after work is done, and whenever there is bad flow.

How to do it?

- Pull up the inlet closing plate and let the machine build up vacuum for 5 sec.
- Push forward the cover lever quickly and then release it.
- Do it five times as you let the machine build up vacuum between each round.
- Stop the dust extractor and wait for the motor to stop fully.
- Push down the inlet closing plate to open the inlet.

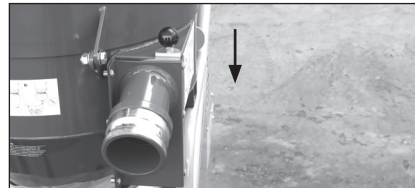
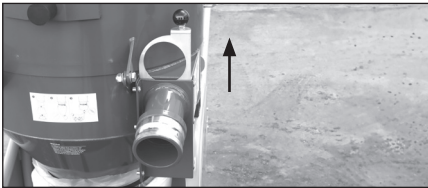

If you need to, use the connected cover to cover the opening. First, let the machine suck for four or five seconds. Then, press down on the key quickly and let go of it. Do what you need to do five times. It's important to let the machine rebuild the pressure between each round.

Turn off the motor and wait for it to stop fully. Then open the intake.

The pre-filter needs to be changed if the pressure stays low. If the flow is still bad after that, the Hepa filters need to be changed.



Filter change

Pre-filter

- Loosen the hooks connecting the tank to the hepa filter box and release the tank outlet.
- Loosen the hooks connecting the upper and lower tank compartments.
- Pull the tank forward and rotate it downwards by using the tank handle then let it hang on its hinges.
- Turn the filter plate 10 degrees clockwise and slowly lift the filter up and take it out.
- Flip it over carefully and put a plastic bag over the filter unit. Tie it up tightly and throw away or dispose properly.



- Put the new filter into the tank and lock it by rotating it 10 degrees counterclockwise.
- Turn back the tank on its position using the tank handle and lock the tank hooks.
- Connect the tank outlet and lock back the hooks.

Hepa filter

- Loosen the hooks connecting the hepa top cover and release it.
- Slowly lift the filter up and take it out.
- Put it carefully in a plastic bag. Tie it up tightly and throw away or dispose properly.
- Put the new filter into the hepa box.
- Close the cover and fasten the hooks.

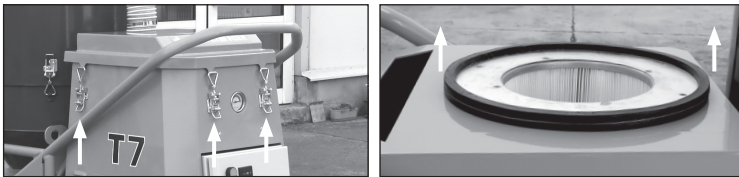

Dust that can be hazardous to one's health and may be dispersed when cleaning the product. Use protective eyewear, gloves, and a respiration mask class FFP3.



Before performing maintenance on the dust extractor, all connected products must be turned off and disconnected.



Before cleaning and servicing the machine, you must switch the machine off and unplug it.



You can't clean Hepa filters; if you try, you might damage them. Make sure not to touch the inside of the filter when you put the new one in. The new filter will not work if there is any force or damage on the inside of the filter media.

New Longopac dust bag assembly



Always clean the pre-filter before change of bag collection system.



The dust extractor has Longopac system.

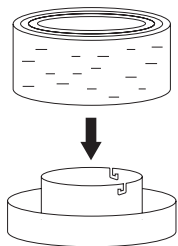

1. The dust bag should be put in the holder

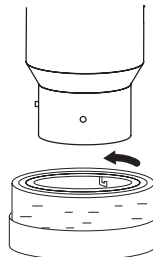

2. Attach the dust bag attachment by twisting it onto the container's holding pins.

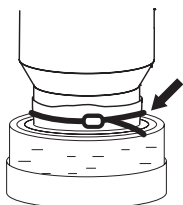

3. Pull the bag up from the bag holder and put it around the container

4. Tighten a strap around the bag and the container to secure the bag to the container



5. Pull the dust bag over the bag holder.

6. Close the bottom of the dust bag with a cable tie.

CARING AND MAINTENANCE

- You have to turn the machine off and unplug it from the power source when you need to clean or fix it.
- Don't use a high-pressure cleaner to clean. If you have to, don't point at the machine's holes, especially the one for the air to cool it.
- The machine needs to be cleaned before it can be moved from the work area.
- The right personnel safety equipment must be used. When the pre-filter and the HEPA filter are to be replaced, dust can be spread, which is hazardous for your health. So, Use safety goggles, safety gloves, and a breathing mask with protection class FFP3.
- All parts that are dirty after repair must be thrown away properly in plastic bags, as per local regulations.
- Don't damage or brake the Hepa filter. There is a risk the dust can spread.

TROUBLESHOOTING

The problem	The reason	The Answer
Motor doesn't start	No power	Plug in machine
	Defective cable	Replace cable
	Contactor combination defective	Replace switch
	Phase error (red lamp lights up)	Reverse phases
	Thermal protection active	Clean or replace filters, check hose and inlet blockage, restart machine.
Motor stops immediately after starting	Wrong fuse	Connect to correct fuse
	Shortcut in cable/machine	Order service
Motor runs but there is not suction	Hose not connected	Connect hose
	Hose blocked	Clean hose
	No dust collection bag	Fit dust collection system
Motor runs but poor suction	Hole in hose	Replace hose
	Filter clogged	Clean filter/Replace filter
	Loose top cover	Adjust
	Dirt in the flap	Clean the flap
	Defective gaskets	Replace affected gaskets
Dust blown from motor	Wrongly assembled or damaged filtersystem	Adjust/Replace filters
Abnormal noise		Order service











TECHNICAL SPECIFICATIONS

T7 EU	
Article code	750010051
Voltage	400 V, 50 Hz
Motor	5,5 kW
Amperage	15 amp
Air flow	600 m3
Vacuum	28 kPa
Inlet size	3" Camlock
Pre-filter	Polyester socks x 15
Pre-filter surface	2.3 m2
Pre-filter %	>99,5%
HEPA filter	H13
HEPA filter surface	5 m2
Jet puls filter cleaning	Yes
Collection	Longopac
Sound level	74 dB(a)
Size	1190×1760×690 mm
Weight	225 kg

T7 US	
Article code	75001021
Voltage	230 V / 60 Hz
Motor	7,5 kW
Amperage	24 amp
Distribution box	100 amp
Air flow	353 cfm
Inlet size	3" Camlock
Vacuum	28 kPa
Pre-filter	Polyester socks x 15
Pre-filter %	>99,5%
Pre-filter surface	25 sqf
HEPA filter	H13
HEPA filter surface	54 sqf
Jet puls filter cleaning	Yes
Sound level	74 dB(a)
Collection	Longopac
Size	47 × 70 × 27"
Weight	496 lbs

T8	
Article code	75001031
Voltage	480 V / 60 Hz
Motor	8,6 kW
Amperage	14 amp
Distribution box	100 amp
Air flow	353 cfm
Vacuum	28 kPa
Inlet size	3" Camlock
Pre-filter	Polyester socks x 15
Pre-filter surface	25 sqf
Pre-filter %	>99,5%
HEPA filter	H13
HEPA filter surface	54 sqf
Jet puls filter cleaning	Yes
Collection	Longopac
Sound level	74 dB(a)
Size	47 × 70 × 27"
Weight	496 lbs

SPARE PARTS AND ACCESSOIRES

<p>Pre filter assembly - 70530700-20</p>		<p>Hepa filter - 91020113-04</p>	
<p>10m x 76mm hose - 601142</p>		<p>7,5m x 50mm hose - 601173</p>	
<p>Longopac, 4 x23m - 7500017</p>		<p>Wand, 3 pieces 50mm - 7500142</p>	
<p>Floor tool dia 50 curve - 7500143</p>		<p>Set of rubber lips L440+395 - 7509996</p>	
<p>Camlock female 3" to 3" (76mm) - 7500145</p>			
<p>Pre-separator for tree-phase dust extractors C5 Big Bag - 800170</p>		<p>Pre-separator for tree-phase dust extractors C5 - 75102051</p>	

i You can download the full spare parts list from our website - www.vonarx.com.

WARRANTY

Von Arx EOOD guarantees perfect operation of the unit for a period of 24 months from the date of purchase. If the product is used in shift operation this warranty period is halved.

Von Arx EOOD checks all units to ensure they are complete and operating correctly before they leave the works.

The customer must check the machine for any defects or damage in transit immediately on receipt and must inform the sales center and the forwarding agent of any damage or defect without delay.

Von Arx EOOD undertakes to correct all faults demonstrably due to defective materials or workmanship within the stated warranty period as quickly as possible or will arrange repair through an official Von Arx Service and sales center.

No liability whatsoever can be accepted for damage due to incorrect handling, disregarding this Operating Manual, overloading, unsuitable use, incorrect maintenance or natural wear and tear. Repairs or modifications made by the purchaser or third parties without our permission in writing are the responsibility of the customer and immediately void our warranty.

In addition, no claim can be considered under the warranty if any parts other than those manufactured or recommended by Von Arx EOOD are used.

Normal wear of consumables (like longopac-bags and filters) are not covered by warranty.

Von Arx EOOD cannot be held liable for any damage or loss incurred by the purchaser directly or indirectly (consequential loss, loss of profit, extra costs, etc.).

Bought parts such as engines, motors, switches etc. are guaranteed within the warranty determination of the corresponding suppliers.

To prove qualification for a warranty you will need the warranty card and a corresponding commercial invoice of your sales center.

EC DECLARATION OF CONFORMITY

In the sense of the EC machine directive 2006/42/CE

We hereby declare that the equipment described below including its concept, construction and design as marketed by our company complies with the relevant fundamental safety and health requirements of the EC directive. This declaration becomes invalid on any unauthorised modification of the equipment.

Designation:	Extraction system
Type:	T7/T8
Serial Nr.:	All manufactured
Year of manufacture:	2024
Country of origin:	Bulgaria
Norms applied:	2011/65/EU 2014/30/EU EN ISO 12100 EN 60034-1 EN 60204-1 EN ISO 13857
Manufacturer:	Von Arx EOOD 20, Nedyalka Shileva str. 4000 Plovdiv Bulgaria
Responsible for documentation:	eng. Maria Spasova
Place and date:	4000 Plovdiv, Bulgaria 01 jul 2024



Fredrik Åkermark
Owner
Von Arx EOOD



